

## Introduction

Today's pet food manufacturers are constantly searching for methods to improve process efficiency, changeover times, and, of course, ensuring product safety. One of the key technologies which can help address and improve all of these factors is the method of pneumatic conveying used in each process step, whether it is for the raw ingredients (major and minors), for the pet food kibble or ingredient blends prior to their next process step or for the final product prior to packaging. Older methods of transferring finished products and even raw ingredients via mechanical means such as drag conveyors or spiral screw conveyors are quickly diminishing. Pneumatic conveying is often chosen as a clean and versatile method for pet food manufacturers to efficiently transfer finished products and raw ingredients from point A to point B in a completely contained manner. Pneumatic conveying offers a much cleaner and safe alternative. By properly selecting the best pneumatic conveying method for the application, a much more cost effective and reliable means of material handling can be achieved. This white paper will outline and define the methods of pneumatic conveying available, with an emphasis on the advantages of dense phase conveying types for a variety of unit operations in pet food processing.

## Pneumatic Transfer: Vacuum or Pressure?

Pet food manufacturing facilities will typically include several pneumatic conveying types. The mode of transfer of raw ingredients or final product is dependent upon many process parameters, including material characteristics, distance to be transferred, required rate of transfer, friability of product and/or segregation concerns. In the case of raw material delivery, the type of container in which the ingredient is originally received can also be a factor. For example, majors such as flour, grains, starches, and sugars are often received by truck or railcar and then stored in silos prior to usage. Pressure Differential (PD) trucks and railcars use positive pressure to unload material, whereas other types of delivery to the blending batching steps can involve either positive pressure or negative pressure. It is therefore important when choosing the conveying method that a full examination of several process parameters be completed, since different options can result in cost savings and efficiency improvements.

Positive pressure systems, such as that shown in Figure 1, are typically used to convey bulk materials from a single source to one or multiple destinations. This is done by use of a positive displacement blower pushing air through material entry points located downstream. These entry points then meter each product into the



conveying line by means of a rotary valve which overcomes the pressure differential between the ambient atmosphere and that of the conveying line. Material and air blown through the line exit at single or multiple use points where they are separated by means of a filter receiver or cyclone separator, or fed directly into process vessels. Positive pressure conveying systems are typically used to transport product over long distances and at high throughputs. Applications which involve pressure conveying often include loading and unloading of large volume vessels such as silos, bins, railcars, trucks, and bulk bags.

Conversely, negative pressure or vacuum systems, such as that shown in Figure 2, are generally used for transporting material from multiple sources such as storage vessels, process equipment, bulk bags,

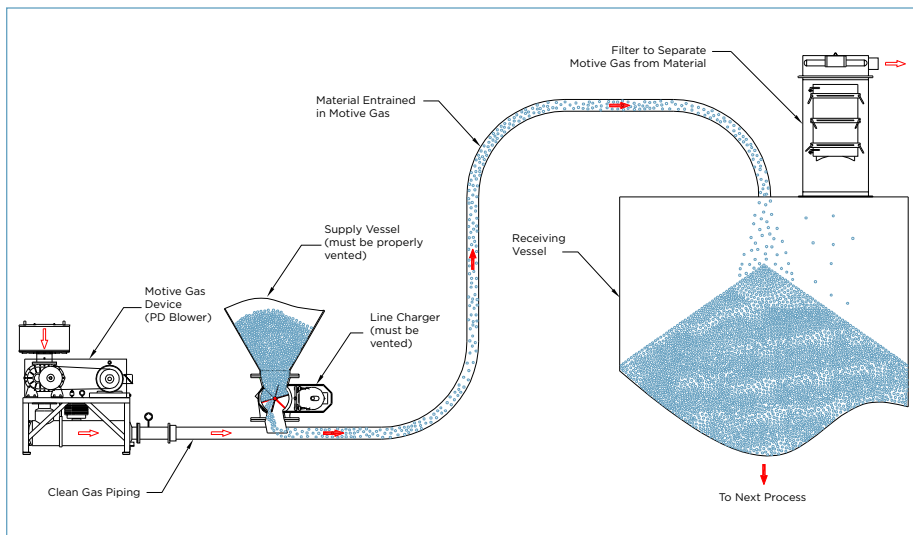

Figure 1 - Typical dilute phase positive pressure system



Photo 1 - Sanitary Design Bag Dump Station

trucks and railcars, to individual or multiple destinations and are typically used for lower volumes and shorter distances. Negative pressure is created by a positive displacement vacuum blower located at the downstream end of the system. Material can enter the system via bag dump stations equipped with rotary valves, as shown in Photo 1, via handheld pickup wands, and via pickup hoppers. Material exits the system through filter receivers that separate the material from the conveying air directly above process equipment, surge hoppers, storage vessels or other discharge points. One of the advantages of vacuum systems is the inward suction created by the vacuum blower and reduction of any outward leakage of dust. This is one of the reasons why vacuum systems are often used in higher sanitary or dust containment applications. Another advantage of vacuum systems is the simple design for multiple pickup points. It should be noted, however, that the distances and throughputs possible with a vacuum system are limited due to the finite level of vacuum that can be generated.

Table 1 outlines just a few of the comparative differences between choosing positive pressure or negative (vacuum) pressure conveying systems.

### Dense Phase or Dilute Phase Conveying?

In addition to the choice of pressure or vacuum, conveying systems are also available in a dilute phase or dense phase of operation. By definition, dense phase means a higher product to gas ratio, conveying below the saltation velocity of the material. Figure 3 shows a graphic illustration of the material to gas ratios in dense and dilute phase systems.

Due to the lower gas velocity used with dense phase conveying, a much gentler action is delivered to the conveyed powder or particle and therefore reduces product degradation. This gentle action also reduces the segregation issues often experienced with the more aggressive dilute phase operation.

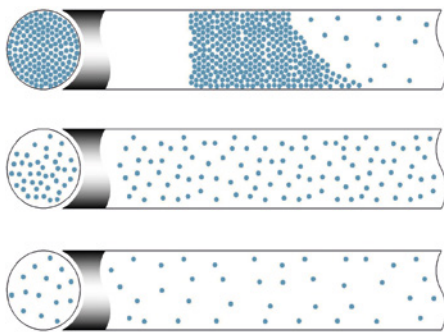

Figure 3 - Examples of material loading dense phase (top) vs. dilute phase (bottom)

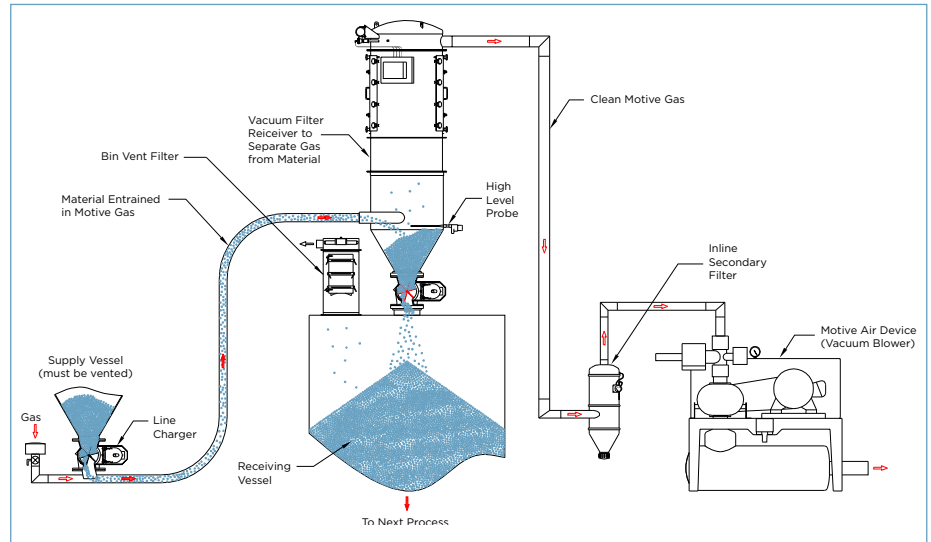

Figure 2 - Typical dilute phase vacuum system

	Pressure System	Vacuum System
Convey Efficiency	<ul style="list-style-type: none"> <li>• More versatile due to available pressure drop across blower</li> <li>• Equivalent rates may require smaller blower</li> <li>• Size and line sizes, possibly less cost</li> </ul>	<ul style="list-style-type: none"> <li>• Vacuum system has less available pressure drop</li> <li>• Equivalent rates may require larger pump and line sizes, possibly higher cost</li> </ul>
Receiving Vessel	<ul style="list-style-type: none"> <li>• Can be at atmospheric pressure and requires less filter area - generally smaller filter size</li> </ul>	<ul style="list-style-type: none"> <li>• Receiving vessel must be able to withstand vacuum and be reinforced accordingly</li> </ul>
Product Temperature	<ul style="list-style-type: none"> <li>• Temperature rise across blower may heat product, may require inline cooling at added cost</li> </ul>	<ul style="list-style-type: none"> <li>• Temp rise is after product conveyed - no rise in product temperature</li> </ul>
Leakage	<ul style="list-style-type: none"> <li>• Powder leakage risks blowing out of convey line to environment</li> </ul>	<ul style="list-style-type: none"> <li>• Negative pressure prevents powder leaks/escape</li> </ul>
System Design	<ul style="list-style-type: none"> <li>• Ideal for multiple destination, typically requires means to overcome pressure differential at inlet, such as rotary airlock</li> </ul>	<ul style="list-style-type: none"> <li>• Ideal for multiple pick up points, simple pick up designs such as wands or pick up hoppers can be used without airlocks</li> </ul>

Table 1 - Comparison of positive pressure vs. vacuum conveying

For these reasons, in pet food operations dense phase conveying is often used to convey the pre-blends before going to the before going to the extruder, as well as the pet food kibble after the drying/coating processes to minimize product degradation. It is important to note that by minimizing any kibble degradation or fines creation, that the system is not only protecting the product integrity, it is also minimizing the generation of additional dusting which can add to possible contamination points in the manufacturing line.

### Dense Phase Vacuum Systems

Dense phase can be used in vacuum systems, as illustrated in Figure 4. This configuration is favored for low distance, low

capacities and for systems where several pick-up points lead to one destination or the head-room is limited. This method is also very well suited to fragile and/or sticky materials since the low velocity is gentler on the material.

The bulk material moves in the form of compact slugs. The slugs normally form naturally after entering the convey line via the rotary valve feeder or vacuum pickup adapter. The slug length results from the balance between the driving forces (air flow) and the resistance forces (pipe friction, material on material friction). Regular fluctuation of the conveying vacuum is normal in order to achieve stable slug formation. The system operates at high vacuum and low air flow with a high material to air ratio, and conveys at velocities well below

the saltation velocity of the material, resulting in lower exit velocity of the material from the convey line into the vacuum filter receiver. Material is continuously conveyed until the system is stopped manually by the operator or automatically when a high level indication is received from the destination.

The advantages of using dense phase vacuum systems include the ability to contain food ingredients more efficiently within the line, due to the vacuum which is pulling inward to the system. In addition, its simple and easy clean design make it an excellent choice for simple up and in applications. It should be noted however, that due to limiting pressure difference it has limitations in conveying distances and rates as compared to dense phase positive pressure systems.

### Dense Phase Positive Pressure

Dense phase pressure systems are used to convey pet food ingredients for a wide range of applications due to their ability to convey efficiently at long distances and high capacities. Utilizing positive pressure dense phase is especially appropriate when handling products which are friable or fragile, have a tendency to segregate, or are temperature or moisture sensitive. They are particularly favored over vacuum dense phase systems when the required pressure difference exceeds 7 psi (0.5 bar) due to higher conveying distances and/or conveying rates. It should also be noted that due to innovations available in the sanitary and hygienic design of the components of a dense phase system, easy clean and disassembly options are available, making them perfect for pet food applications.

Typical dense phase positive pressure systems as utilized in the pet food industry can be broken down into two categories as follows:

- Dense Phase Pressure Vessel Systems
- Dense Phase Rotary Valve Pressure Systems

### Dense Phase Pressure Vessel Systems Defined

Compared to rotary valves the pressure vessel has less mechanical limitations and can therefore be operated at a much higher pressure. Other advantages of the pressure vessel are the fact that no moving parts are in contact with the product and no leakage gas has to be handled during conveying. Basic operation consists of the pressure vessel being filled from another vessel or device by gravity. When the pressure vessel is full, the inlet and vent valves close, the convey system is pressurized, and the material flows into the convey line to the destination selected. In some cases the convey line is equipped with supplementary air (or bypass air) injectors to aid in

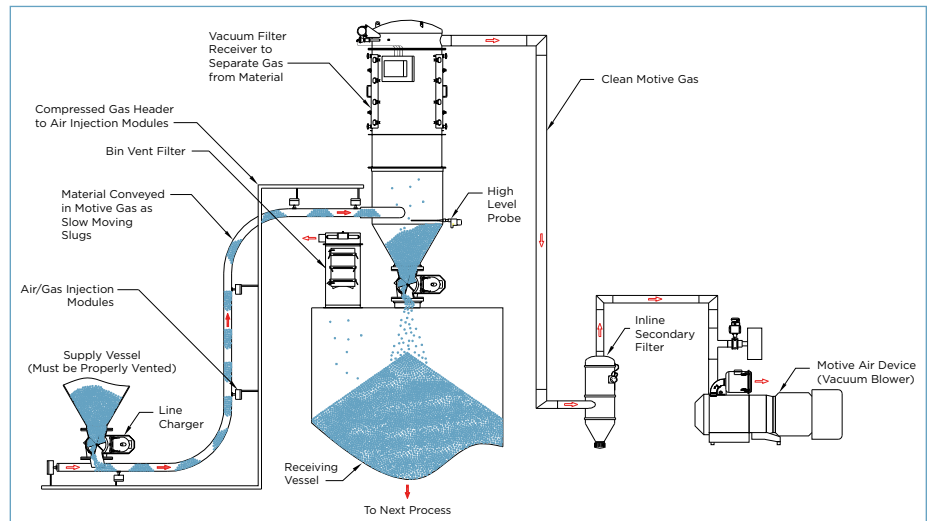

Figure 4 - Typical dense phase vacuum system

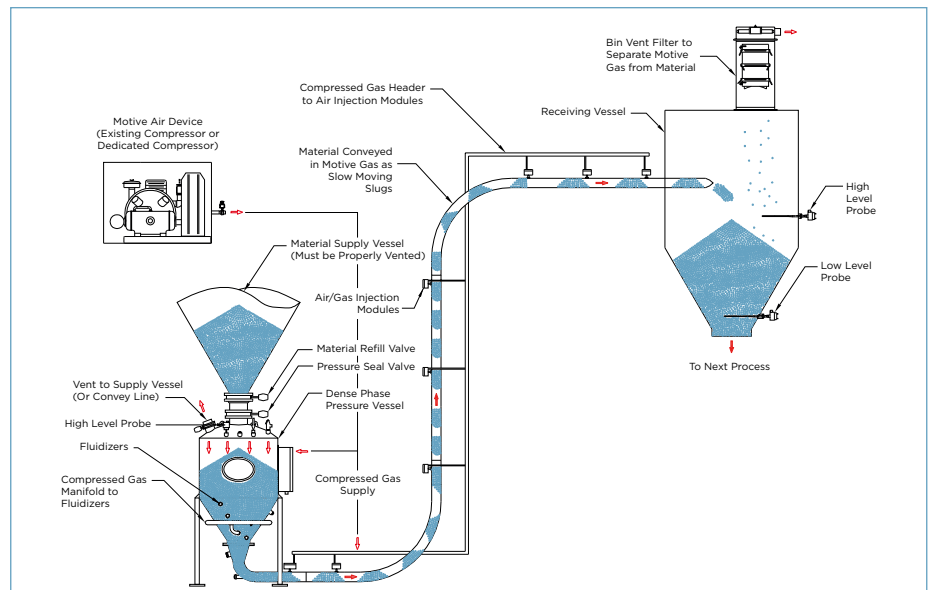

Figure 5 - Typical dense phase purged system with pressure vessel

material flow and minimize material velocity in the convey line.

Injecting small amounts of air at strategic points along the convey line in a dense phase system will help to maintain slug flow. The air injection points will break down the convey distance into several smaller distances thereby reducing the resistance and pressure necessary to move the material through the convey line. The resulting slug flow reduces the area of material in contact with the convey line inner diameter, and therefore reduces degradation and segregation.

Dense phase pressure vessel systems can be further broken down into two types of configurations, described as follows.

### Purged System for Pressure Dense Phase Conveying

A purged system is excellent for high conveying rates and/or long conveying

distances (300+ linear feet or 90+ linear meters) for powders and granules. The vast majority of the conveying will occur in dense phase mode until the very end of a convey cycle. At the end of the cycle, an additional system line purge is added to the convey line in order to clear the line. At this point, it is important to note that the material velocity can equal that of dilute phase mode conveying for a short period.

As shown in Figure 5, material will discharge by gravity from the material supply vessel into the dense phase pressure vessel. When material is in contact with the pressure vessel high level control, the pressure vessel inlet and vent valves will close, and the convey cycle will be initiated. The material in the pressure vessel will be conveyed in the form of low velocity slugs to the receiving vessel. When the convey cycle is complete the pressure vessel inlet and vent valves will open and the pressure



vessel will load again. The dense phase system will continue to load and convey material to the receiving vessel as needed as long as material is provided, there are no alarms, the operator does not terminate or stop the dense phase transport system, or until the receiving vessel signals no additional material is required.

Each receiving vessel must have a venting device (dust collector) capable of separating and dissipating the conveying air from the material. In addition, this device must be kept clean by some mechanism (such as reverse jet pulsing) during the conveying cycle.

It should be noted that a fully purged system offers some disadvantages particularly for the small to medium sized rates prevalent in many food systems. In these systems, if the system is allowed to decompress at the end of a convey cycle the velocities can be very high. High velocity purging of each cycle can cause damage, additional abrasion issues, and additional degradation to a noticeable amount of material. For these instances, the fewer decompression cycles the better, and the automated control non-purged systems are recommended as outlined below.

### Non-Purged (or Full Line) System for Pressure Vessel Dense Phase Conveying

This is the most common configuration for a dense phase pressure vessel system where the objective is not to degrade or segregate the material. In this case, the entire conveying will occur in dense phase mode as the system will depressurize when material reaches a low level in the pressure vessel. With a control system, such as those provided through Coperion and Coperion K-Tron, conveying can be resumed even if the cycle is stopped with a full line without purging. This avoids the issues of abrasion, degradation and attrition typically seen with purged lines and quickly becomes the hardware and software configuration of choice.

As illustrated in Figure 6, material will discharge by gravity from the material supply vessel into the dense phase pressure vessel. When material is in contact with the pressure vessel high level control, the pressure vessel inlet and vent valves will close, and the convey cycle will be initiated. The material in the pressure vessel will be conveyed in the form of low velocity slugs to the receiving vessel. The convey cycle will be completed when the material uncovers the low level control in the pressure vessel, at which time all compressed air supplies to the system will cease. The material in the convey line will come to rest in the convey line and any excess pressure will be vented off. When the convey cycle is complete the pressure vessel inlet and vent

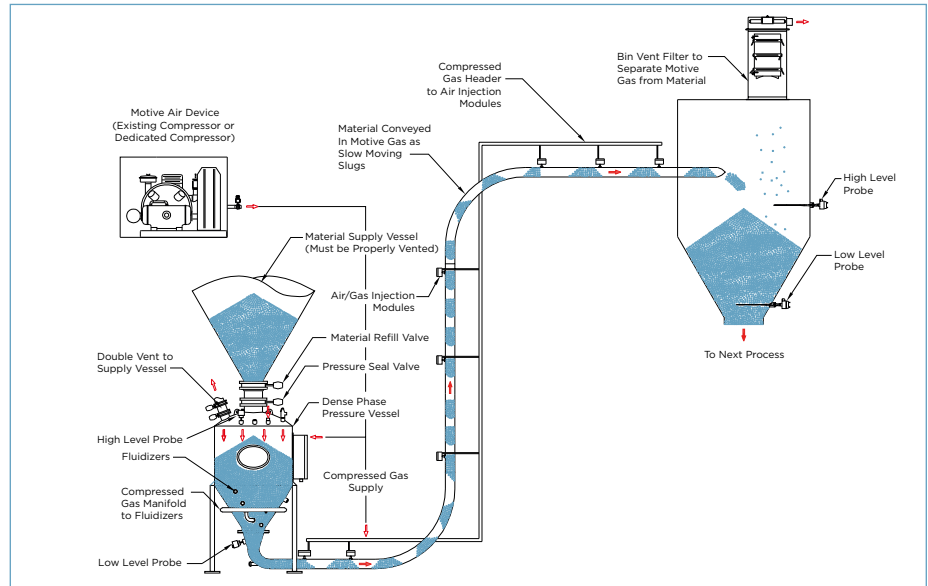

Figure 6 - Typical dense phase non-purged system with pressure vessel

valves will open and the pressure vessel will load again.

When material uncovers the level probe, then all air input to the system is turned off and the material falls in the line where it lies until the next convey cycle. Any residual pressure in the vessel is vented through a second vent valve on the pressure vessel. In non-purge systems, on the next cycle, the material that was in the line is picked up and conveyed using the air injection modules. Therefore, the non-purge system is a first in, first out method. For these reasons, it is the most gentle way to handle friable (fragile) materials as there is no purge at the end of the cycle where material can reach higher dilute phase velocities.

### Dense Phase Continuous Rotary Valve Systems

As an alternative to the pressure vessels, rotary valves can be used for product feeding in dense phase systems. Coperion offers high pressure rotary valves for granular products as well as for powders. These valves are designed to allow dense phase conveying for a wide range of products, suitable for conveying pressures up to 50 psi [3.5 bar(g)]. This low velocity makes this type of bulk solid materials conveying especially suitable for friable materials and ideal for products like pet food kibble. Basic operation consists of the high pressure rotary valve being filled from another vessel or device by gravity (Note that the surge vessel does not need to be a pressure vessel). When the high pressure rotary valve is started, and conveying air is supplied to the rotary valve line adapter, the material is directly picked up by the air stream and carried to the destination selected. The Coperion high pressure rotary valves are designed to minimize the leakage air from



Photo 2 - Dense phase conveying system with rotary valve

the convey line up into the vessel above the high pressure rotary valve by venting it. This allows more stable and more efficient operation as more conveying air is being used to convey material and the minimum amount of air is lost to leakage through the high pressure rotary valve.

It should also be noted that specific rotary valve designs are available which make them ideal for gentle handling of pet food products like pet food kibble. These valves, such as the ZVB shown in Figure 7 include optimized inlet geometries which result in a much gentler handling of the product

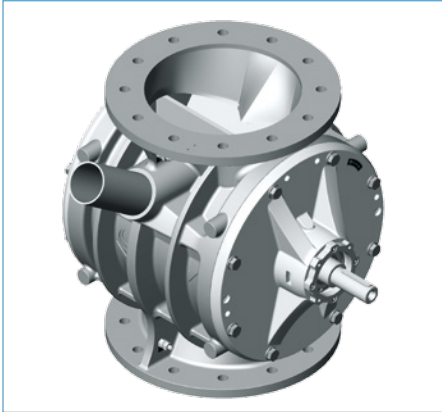

Figure 7 - ZVB rotary valve

during introduction to the metering vanes of the rotary valve, as well as improving the overall capacity through the valve. By using these valve designs in the systems outlined below, all automated transfer of the product can be done without degradation of “chopping” of the finished kibble.

Dense phase continuous rotary valve systems for conveying of granular products can be broken down into two types of configurations:

- Dense Phase Continuous Rotary Valve Pneumatic Conveying via Natural Slug Formation
- Dense Phase Continuous Rotary Valve Pneumatic Conveying via Artificial Slug Formation

### Natural Slug Formation

Natural slug formation is mainly depending on material characteristics, product to gas ratio and air velocity. Also the pipe routing can have an impact on the slug

formation. If natural slug formation is possible, a configuration as shown in Figure 8 can be used. A special discharge adapter (or ‘feeding shoe’, see Photo 4) is used to provide a certain volume at the pick-up point and allow slug formation. In this way the conveying station can be constructed in a very compact way. This is especially convenient for applications where there is very little headroom available for equipment installation.

The bulk material moves in the form of slugs traveling over a thin bed of the material. Material is constantly exchanged between the bed and the slug as it moves through the convey line. The slugs form naturally after entering the convey line via the high pressure rotary valve. The slug length results from the balance between the driving forces (air flow) and the resistance forces (pipe friction, material on material friction). Regular fluctuation of the conveying pressure is normal and is indicative of stable slug formation. The system operates at high pressure and low air flow with a high material to air ratio. Conveying velocities are typically well below the saltation velocity of the material, resulting in lower exit velocity of the material from the convey line.

### Artificial Slug Formation

Artificial slug formation is used when the material characteristics are not in favor of natural slug formation. Especially for very porous materials or materials with low inner friction (free flowing) materials, high lubricant content), natural slug formation is not possible. Also the system design can cause the requirement for a setup with artificial slug formation. This is especially the case, when the conveying line is mainly horizontal. Another reason can be a relatively low product to gas ratio. Also in this case a setup for artificial slug formation is required to create stable slugs with defined size. A typical system setup is shown in Figure 9. The high pressure rotary valve is metering the product into a special discharge adapter where the slugs are formed artificially. Continuous material slug conveying is achieved by alternating the supply of primary air source, and intermittent secondary air injection based on a point level indicator in the rotary valve’s special discharge adapter. The slug length is determined by the volume of the discharge adapter and can be regulated by the pulse time. The secondary air utilizes the same air source as the primary conveying air, so no additional air source is required. In summary the artificial slug formation allows the application of dense phase conveying to a wider range of materials and systems, providing all benefits of stable slug conveying.

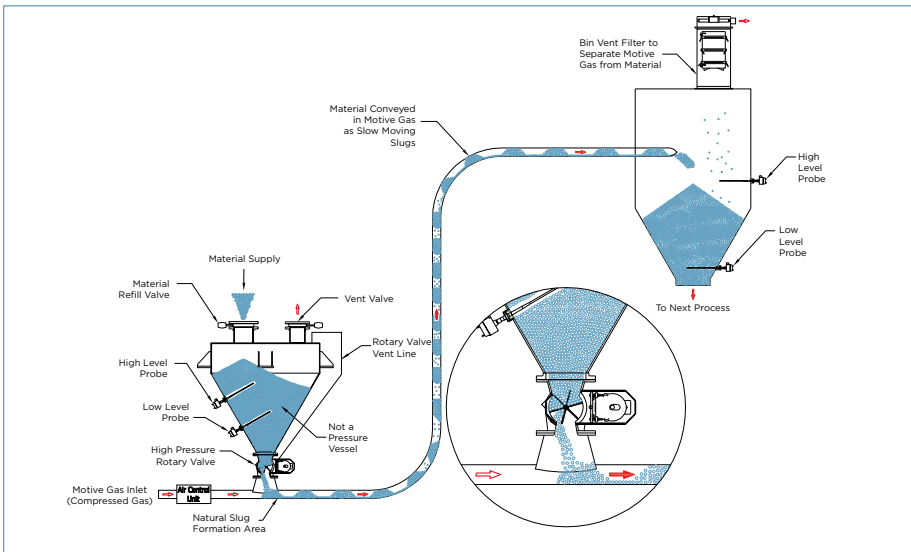

Figure 8 - Natural slug formation

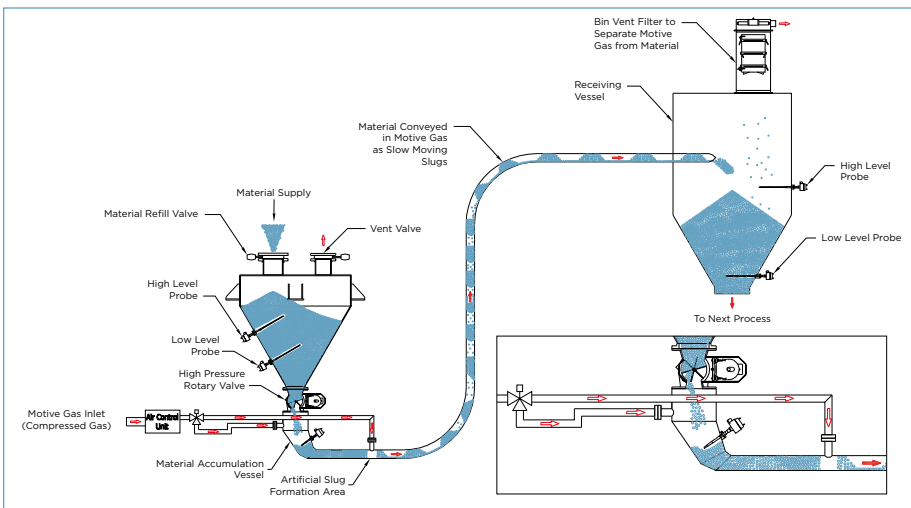

Figure 9 - Artificial slug formation

## Options for Cleaning and Improved Food Safety in Pet Food Conveying Systems

Food safety and contamination avoidance is of utmost importance when handling any food product. Due to a variety of options available in safe and efficient process equipment design, it is very important that the equipment manufacturer be experienced in a variety of engineering design regulations and standards, such as EHEDG, FSMA, GFSI, USDA, 3A, etc. Today's pet food manufacturers require equipment partners who can not only educate them in the options available to meet these standards, but also ensure a cost effective process solution.

It is important to note that for ease in cleaning and product changeover, pet food conveying designs are available for all of the conveying methods outlined above to ensure minimal downtime and to ensure the system is completely cleaned and safe. Equipment manufacturers who can provide these key insights into their designs are quickly becoming the equipment partners of choice. In addition, design innovations are also available for all the pneumatic conveying and handling systems prior to and after the processing step.

For example, one such design involves unique, easy access of cleanable rotary and diverter valves for use throughout the pneumatic conveying process. These valves can incorporate a number of design features including complete access of both the rotor and drive ends, as shown in Photo 5.

The Coperion K-Tron Sanitary Filter Receiver (SFR) has been completely designed and engineered based upon in-depth discussions with pneumatic conveying receiver users in the food industry. The unique top entry and special custom engineered side access filter assembly of the SFR allows for high efficiencies, with minimal degradation of the product due to decreased can

velocities, and extremely high access to all internal areas of the receiver for cleaning. In addition, the availability of oleophobic filter material for this type of filter can be especially important when dealing with high fat content ingredients or materials which are oily in nature, such as high fat content kibble.

The reduction in time alone for complete filter change out and cleaning compared to typical side tangential inlet, top removal cartridge or bag filter designs can be significant to overall process and product changeover times. It is important that the equipment manufacturer discuss in detail with the end user the methods of cleaning that will be used for the process, for example either wet or dry, and make design recommendations to accommodate the cleaning process, such as retractable spray balls for CIP/WIP systems, or minimal horizontal ledges which can be easily wiped clean for dry cleaning. By including upfront design features which focus on accessibility and ease of cleaning, food process times can ensure product safety as well as quick changeover times.

In addition to cleanability of the pneumatic conveying system, it is also important to evaluate any dust control or explosive concerns, particularly in dealing with palatants (flavor enhancers) added to the dried kibble. Whole kibbles are generally benign and easy to handle, however, considerations must be made when handling palatants. It is crucial that dry palatant material handling, application design and recovery devices have adequate dust control to minimize and protect against dust creation as some palatants can be an irritant or possess characteristics of an explosive dust.

## Summary

As outlined above, a variety of pet food conveying methods are available complete with options in design and configuration to ensure minimal degradation of the product as well as optimized efficiency. It is important to evaluate your complete system and material requirements with your conveying system supplier to ensure that the most cost effective, efficient and most importantly, safe design is provided.



Photo 4 - Hygienic rotary valve with quick extraction system

To download other papers in this series,  
or for more information on  
Coperion K-Tron equipment and  
services, please visit

[www.coperion.com](http://www.coperion.com)

